

B35035 Turret T-72A m1981 "Dolly Parton"

INCLUDES RESIN PARTS (r), PHOTOETCH PARTS (p)
FOR TRUMPETER, MENG, TAMIYA KITS

CAUTION!
Resin parts can only be glued using cyanoacrylate glues. Work in a well ventilated area. Do not inhale vapors since these can be harmful.

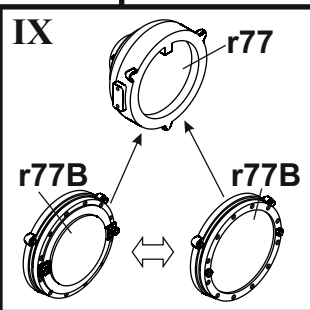
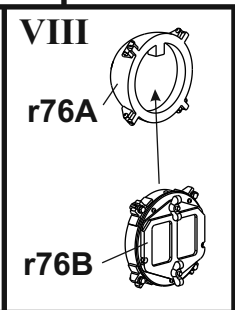
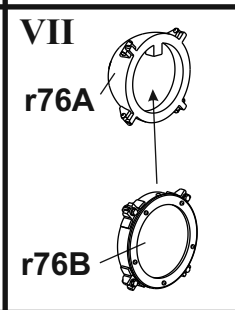
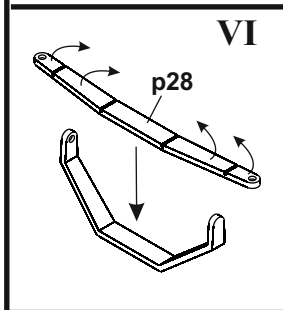
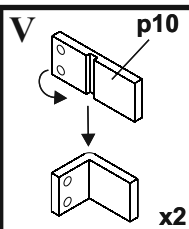
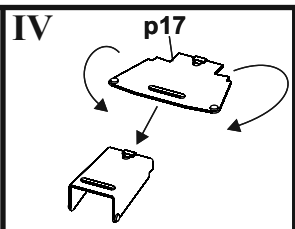
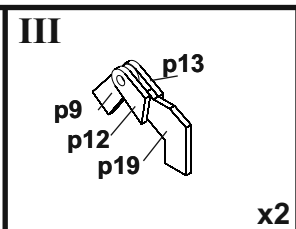
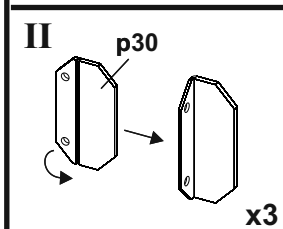
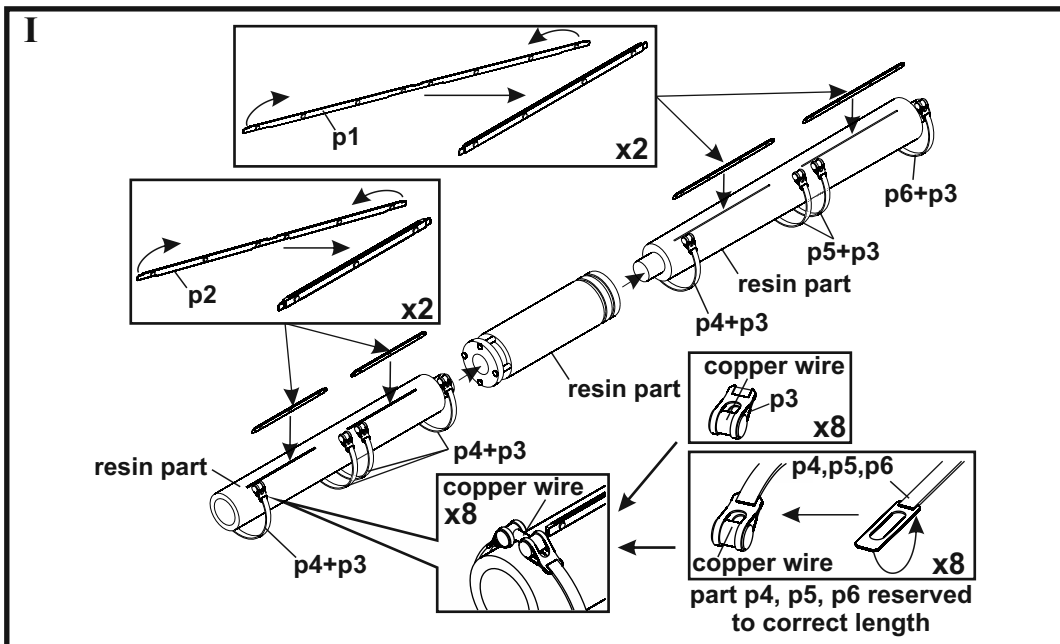

B35035 Turret T-72A m1981 "Dolly Parton"

INCLUDES RESIN PARTS (r), PHOTOETCH PARTS (p)
FOR TRUMPETER, MENG, TAMIYA KITS

CAUTION!
Resin parts can only be glued using cyanoacrylate glues. Work in a well ventilated area. Do not inhale vapors since these can be harmful.

